

MANUAL DE INSTALACIÓN

Vista Frontal



Vista Posterior







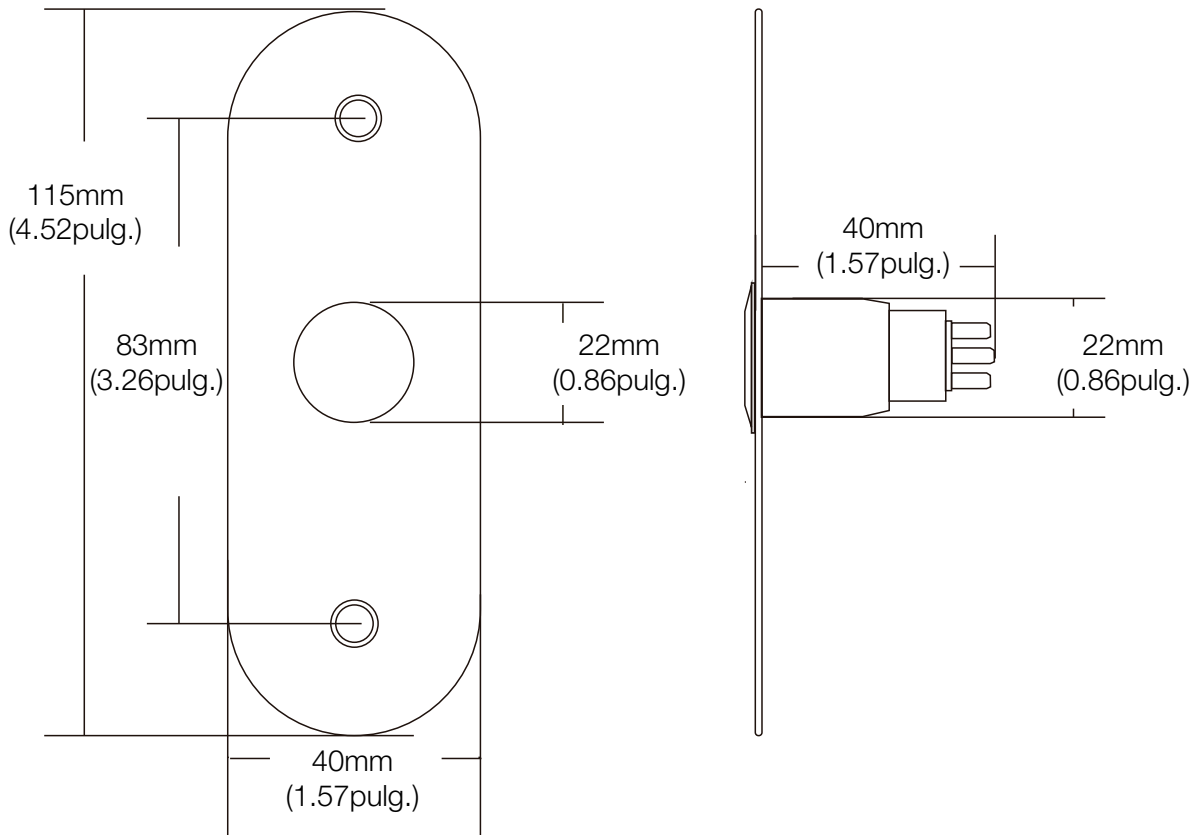

Diagrama de Cableado

	Verde (1): COM
	Verde (2): COM
	Blanco: NC
	Amarillo: NO
	Rojo: +12VDC
	Negro: -GND

- (1) Índice de contacto en seco del botón de presión: 250VAC 5A. Para operaciones seguras, no exceda las clasificaciones anteriores.
- (2) Para requerimiento de normalmente abierto, conectar los cables al contacto seco N.O del botón de salida.
- (3) Para requerimiento de normalmente cerrado, conectar los cables al contacto seco N.C del botón de salida.
- (4) Voltaje del LED: DC-12V.

