



VIS-FFSD2

Face Recognition + Fever Screening



Quick Start Guide

Call: 1-800-340-0727

www.visionistech.com

Thanks for purchasing our products, please read the instructions before installing and programming the device. For more detailed functions and user setting please refer to the User Manual: <https://www.visionistech.com/vis-ffsd2-manual/>

About this Manual
This Manual is applicable to face recognition terminal. The Manual includes instructions for using and managing the product. Pictures, charts, images and all other information hereinafter are for description and explanation only. The information contained in the Manual is subject to change, without notice, due to firmware updates or other reasons. Please find the latest version in the company website.
Please use this user manual under the guidance of professionals.
Legal Disclaimer
REGARDING TO THE PRODUCT WITH INTERNET ACCESS, THE USE OF PRODUCT SHALL BE WHOLLY AT YOUR OWN RISKS. OUR COMPANY SHALL NOT TAKE ANY RESPONSIBILITIES FOR ABNORMAL OPERATION, PRIVACY LEAKAGE OR OTHER DAMAGES RESULTING FROM CYBER ATTACK, HACKER ATTACK, VIRUS INSPECTION, OR OTHER INTERNET SECURITY RISKS; HOWEVER, OUR COMPANY WILL PROVIDE TIMELY TECHNICAL SUPPORT IF REQUIRED.
SURVEILLANCE LAWS VARY BY JURISDICTION. PLEASE CHECK ALL RELEVANT LAWS IN YOUR JURISDICTION BEFORE USING THIS PRODUCT IN ORDER TO ENSURE THAT YOUR USE CONFORMS THE APPLICABLE LAW. OUR COMPANY SHALL NOT BE LIABLE IN THE EVENT THAT THIS PRODUCT IS USED WITH ILLEGITIMATE PURPOSES.
IN THE EVENT OF ANY CONFLICTS BETWEEN THIS MANUAL AND THE APPLICABLE LAW, THE LATER PREVAILS.
Data Protection
During the use of device, personal data will be collected, stored and processed. To protect data, the development of our devices incorporates privacy by design principles. For example, for device with facial recognition features, biometrics data is stored in your device with encryption method; for fingerprint device, only fingerprint template will be saved, which is impossible to reconstruct a fingerprint image.
As data controller, you are advised to collect, store, process and transfer data in accordance with the applicable data protection laws and regulations, including without limitation, conducting security controls to safeguard personal data, such as, implementing reasonable administrative and physical security controls, conduct periodic reviews and assessments of the effectiveness of your security controls.

Make sure the power supply is used indoors, and the working temperature is between 0 and 40 °C.

1 Appearance

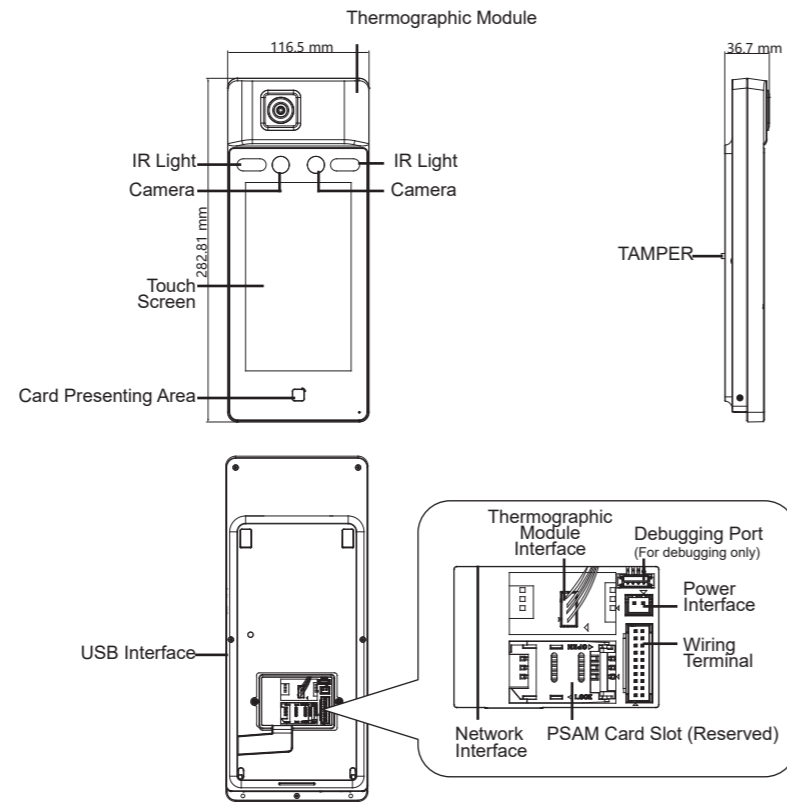

The figures are for reference only.

2 Installation

Installation Environment:

- The device should be at least 2 meters away from the light, and at least 3 meters away from the window.
- Make sure the environment illumination is more than 100 Lux.
- Indoor and windless environment use only.

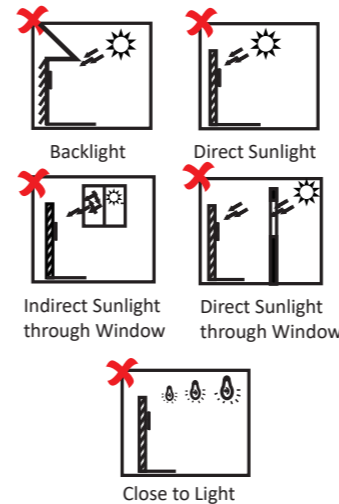

Steps:

- Make sure the output of external power supply fulfils LPS.
 - Drill holes on the wall or other surface and install the gang box.
Use two supplied screws (4_KA4×22-SUS) to secure the mounting plate on the gang box.
Use another 4 supplied screws to secure the mounting plate on the wall.
Route the cables through the cable hole of the mounting plate, and connect to the corresponding external devices' cables.
 - Align the device with the mounting plate and hang the terminal on the mounting plate.
Make sure the two sheets on each side of the mount plate have been in the holes at the back of the device.
 - Use 2 supplied M4 screws to secure the device and the mounting plate.
- When the screw's head is beneath the device surface, the device is secured.
 - The installation height here is the recommended height. You can change it according to your actual needs.
 - You can also install the device on the wall or other places without the gang box. For details, refer to the User Manual.
 - For easy installation, drill holes on mounting surface according to the supplied mounting template.

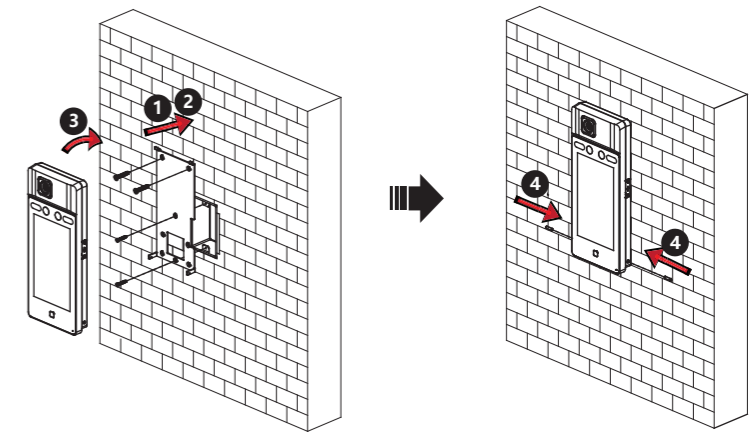

3.1 Device Wiring (Normal)

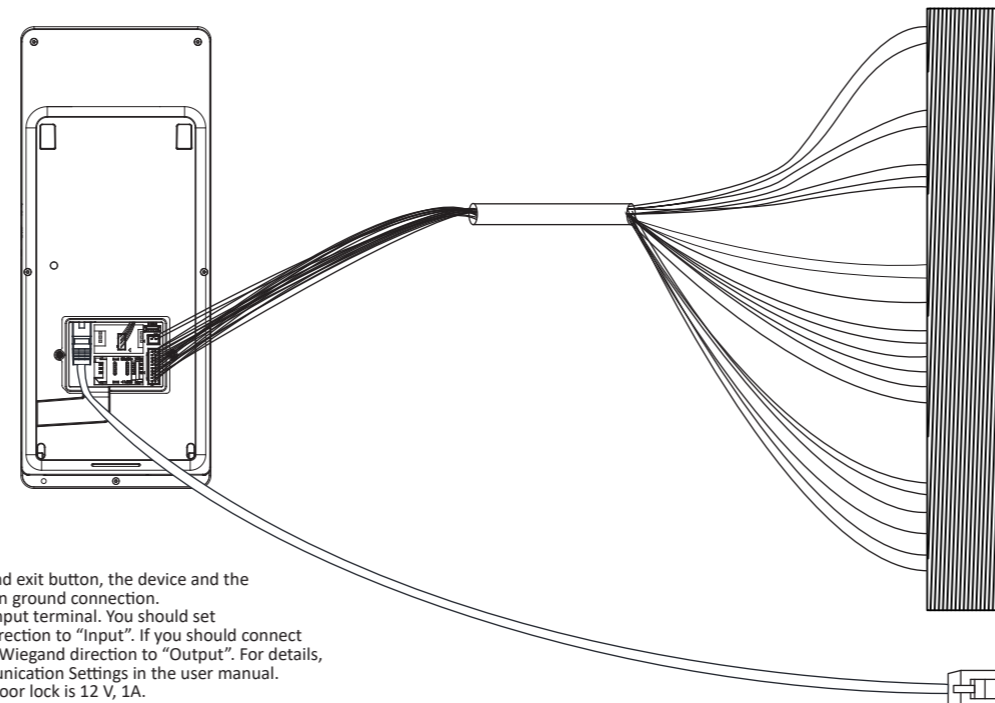

- When connecting door magnetic sensor and exit button, the device and the RS-485 card reader should use the common ground connection.
- The Wiegand terminal here is a Wiegand input terminal. You should set the face recognition terminal's Wiegand direction to "Input". If you should connect to an access controller, you should set the Wiegand direction to "Output". For details, see Setting Wiegand Parameters in Communication Settings in the user manual.
- The suggested external power supply for door lock is 12 V, 1A.
- The suggested external power supply for Wiegand card reader is 12 V, 1 A.
- Do not wire the device to the electric supply directly.

Power Input

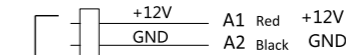

Alarm Input

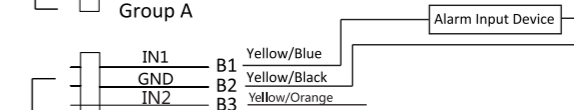

Alarm Output

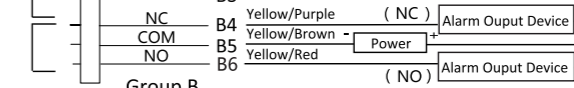

RS-485

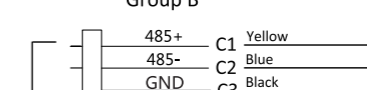

Wiegand

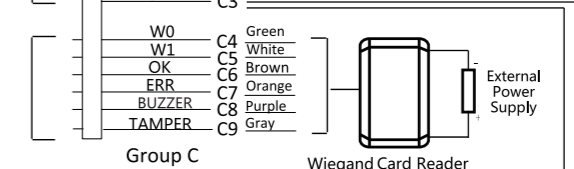

Door Lock

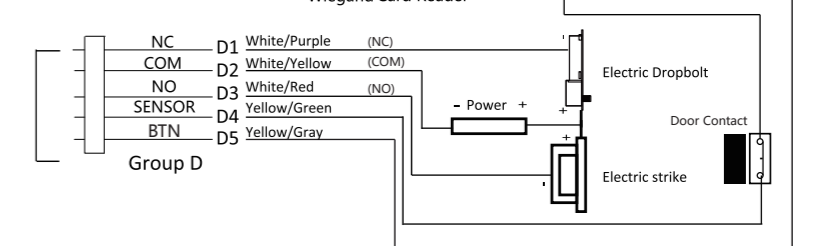

Network Interface

3.2 Device Wiring (With Secure Door Control Unit)

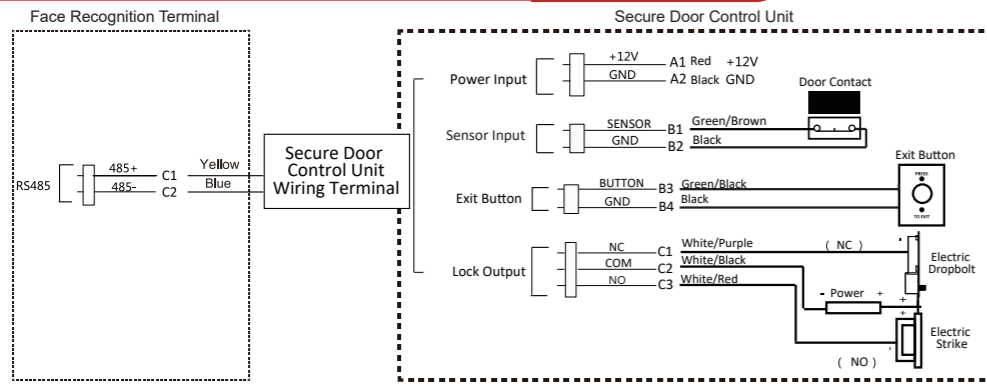

The secure door control unit should connect to an external power supply separately. The suggested external power supply is 12 V, 0.5 A.

4 Activation

Power on and wire the network cable after installation. You should activate the device before the first login. If the device is not activated yet, it will enter the Activate Device page after powering on.

Steps:

1. Create a password and confirm the password.
 2. Tap **Activate** to activate the device.
- For other activation methods, see the device user manual.

STRONG PASSWORD RECOMMENDED— We highly recommend you create a strong password of your own choosing (using a minimum of 8 characters, including upper case letters, lower case letters, numbers, and special characters) in order to increase the security of your product. And we recommend you reset your password regularly, especially in the high security system, resetting the password monthly or weekly can better protect your product.

6 Adding Face Information

1. Hold the screen surface and verify the identity to enter the main page.
2. Enter the User Management page, tap + to enter the Add User page.
3. Set the user parameters according to actual needs.
3. Tap **Face** and collect the face information according to the instructions. You can view the captured picture at the upper right corner of the page. Make sure the face picture is in good quality and size. For details about the tips and positions when collecting or comparing the face picture, see the contents on the right.
5. Tap ✓ to save the settings. Go back to the initial page to start authentication. For other authentication methods, see the device user manual. Use other authentication methods if the device is affected by the light or other items.

Biometric recognition products are not 100% applicable to anti-spoofing environments. If you require a higher security level, use multiple authentication modes.

Tips When Collecting/Comparing Face Picture Expression

- Keep your expression naturally when collecting or comparing face pictures, just like the expression in the picture on the right.
- Do not wear hat, sunglasses, or other accessories that can affect the facial recognition function.
- Do not make your hair cover your eyes, ears, etc. and heavy makeup is not allowed.



Posture

In order to get a good quality and accurate face picture, position your face looking at the camera when collecting or comparing face pictures.

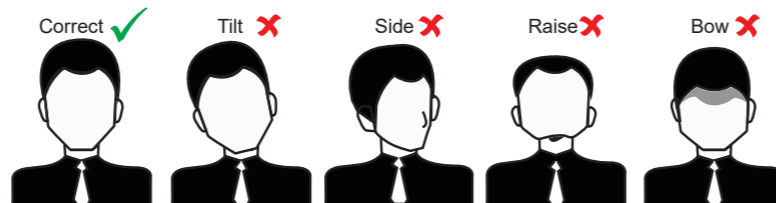

Size

Make sure your face is in the middle of the collecting window.

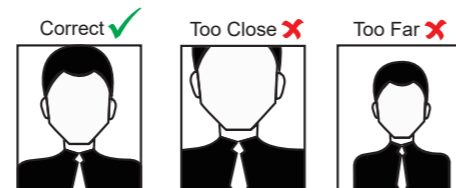

Positions When Collecting/Comparing Face Picture (Recommended Distance: 0.5m)

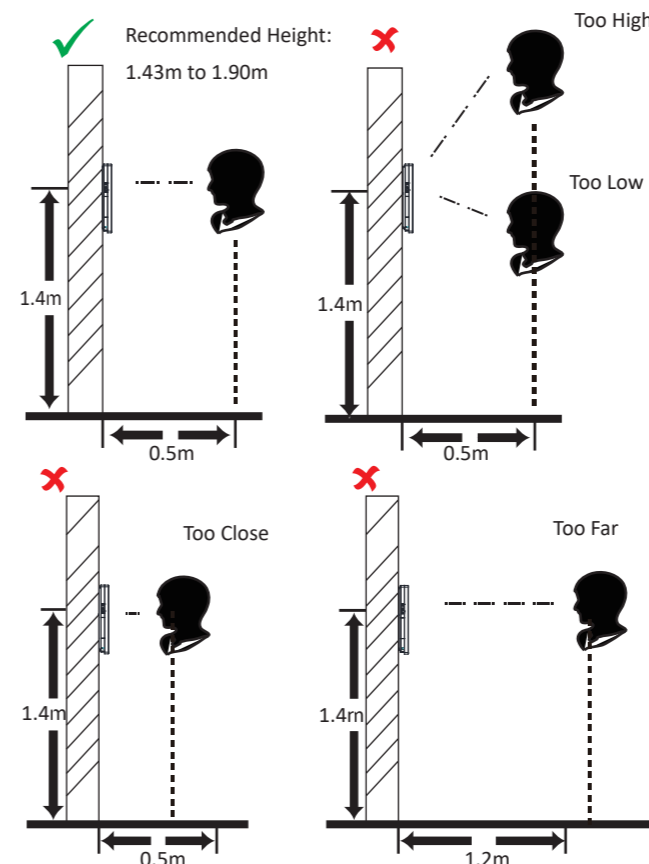

5 Temperature Measurement Settings

1. Hold the screen surface and verify the identity to enter the main page.
2. Tap "Temperature" to enter the Temperature Settings page. Configure the parameters.

- **Enable Temperature Detection:** When enabling the function, the device will authenticate the permissions and at the same time take the temperature. When disabling the device, the device will authenticate the permissions only.
- **Over-Temperature Alarm Threshold:** Edit the threshold according to actual situation. If the detected temperature is higher than the configured one, an alarm will be triggered. By default, the value is 37.3°.
- **Door Not Open When Detecting Abnormal Temperature:** When Enabling the function, the door will not open when the detected temperature is higher than the configured temperature threshold. By default, the temperature is enabled.
- **Temperature Measurement Only:** When enabling the function, the device will not authenticate the permissions, but only take the temperature. When disabling the function, the device will authenticate the permissions and at the same time take the temperature.
- **Measurement Area Calibration/Measurement Area Settings** Configure the temperature measurement area and the correction parameters.
- **Black Body Settings:** When enabling the function, you can configure the black body's parameters, including the distance, temperature, and emissivity.

Regulatory Information

FCC Information
Please take attention that changes or modification not expressly approved by the party responsible for compliance could void the user's authority to operate the equipment.
FCC compliance: This equipment has been tested and found to comply with the limits for a Class B digital device, pursuant to part 15 of the FCC Rules. These limits are designed to provide reasonable protection against harmful interference in a residential installation. This equipment generates, uses and can radiate radio frequency energy and, if not installed and used in accordance with the instructions, may cause harmful interference to radio communications. However, there is no guarantee that interference will not occur in a particular installation. If this equipment does cause harmful interference to radio or television reception, which can be determined by turning the equipment off and on, the user is encouraged to try to correct the interference by one or more of the following measures:
—Reorient or relocate the receiving antenna.
—Increase the separation between the equipment and receiver.
—Connect the equipment into an outlet on a circuit different from that to which the receiver is connected.
—Consult the dealer or an experienced radio/TV technician for help.
This equipment should be installed and operated with a minimum distance 20cm between the radiator and your body.

FCC Conditions
This device complies with part 15 of the FCC Rules. Operation is subject to the following two conditions:
1. This device may not cause harmful interference.
2. This device must accept any interference received, including interference that may cause undesired operation.



This product and - if applicable - the supplied accessories too are marked with "CE" and comply therefore with the applicable harmonized European standards listed under the RE Directive 2014/53/EU, the EMC Directive 2014/30/EU, the RoHS Directive 2011/65/EU.
2006/66/EC (battery directive): This product contains a battery that cannot be disposed of as unsorted municipal waste in the European Union. See the product documentation for specific battery information. The battery is marked with this symbol, which may include lettering to indicate cadmium (Cd), lead (Pb), or mercury (Hg). For proper recycling, return the battery to your supplier or to a designated collection point. For more information see: www.recycle-this.info
2012/19/EU (WEEE directive): Products marked with this symbol cannot be disposed of as unsorted municipal waste in the European Union. For proper recycling, return this product to your local supplier upon the purchase of equivalent new equipment, or dispose of it at designated collection points. For more information see: www.recyclethis.info

Safety Instruction

These instructions are intended to ensure that user can use the product correctly to avoid danger or property loss.
The precaution measure is divided into Warnings and Cautions:
Warnings: Neglecting any of the warnings may cause serious injury or death.
Cautions: Neglecting any of the cautions may cause injury or equipment damage.

- ⚠ **Warnings**
 - All the electronic operation should be strictly compliance with the electrical safety regulations, fire prevention regulations and other related regulations in your local region.
 - Please use the power adapter, which is provided by normal company. The power consumption cannot be less than the required value.
 - Do not connect several devices to one power adapter as adapter overload may cause over-heat or fire hazard.
 - Please make sure that the power has been disconnected before you wire, install or dismantle the device.
 - When the product is installed on wall or ceiling, the device shall be firmly fixed.
 - If smoke, odors or noise rise from the device, turn off the power at once and unplug the power cable, and then please contact the service center.
 - If the product does not work properly, please contact your dealer or the nearest service center. Never attempt to disassemble the device yourself. (We shall not assume any responsibility for problems caused by unauthorized repair or maintenance.)
- ⚠ **Cautions**
 - Do not drop the device or subject it to physical shock, and do not expose it to high electromagnetic radiation. Avoid the equipment installation on vibrations surface or places subject to shock (ignorance can cause equipment damage).
 - Do not place the device in extremely hot (refer to the specification of the device for the detailed operating temperature), cold, dusty or damp locations, and do not expose it to high electromagnetic radiation.
 - The device cover for indoor use shall be kept from rain and moisture.
 - Exposing the equipment to direct sun light, low ventilation or heat source such as heater or radiator is forbidden (ignorance can cause fire danger).
 - Do not aim the device at the sun or extra bright places. A blooming or smear may occur otherwise (which is not a malfunction however), and affecting the endurance of sensor at the same time.
 - Please use the provided glove when open up the device cover, avoid direct contact with the device cover, because the acidic sweat of the fingers may erode the surface coating of the device cover.
 - Please use a soft and dry cloth when clean inside and outside surfaces of the device cover, do not use alkaline detergents.
 - Please keep all wrappers after unpack them for future use. In case of any failure occurred, you need to return the device to the factory with the original wrapper. Transportation without the original wrapper may result in damage on the device and lead to additional costs.
 - Improper use or replacement of the battery may result in hazard of explosion. Replace with the same or equivalent type only. Dispose of used batteries according to the instructions provided by the battery manufacturer.
 - Biometric recognition products are not 100% applicable to anti-spoofing environments. If you require a higher security level, use multiple authentication modes.
 - Indoor use. If installing the device indoors, the device should be at least 2 meters away from the light, and at least 3 meters away from the window or the door.
 - Input voltage should meet both the SELV (Safety Extra Low Voltage) and the Limited Power Source with 100~240 VAC or 12 VDC according to the IEC60950-1 standard. Please refer to technical specifications for detailed information.