

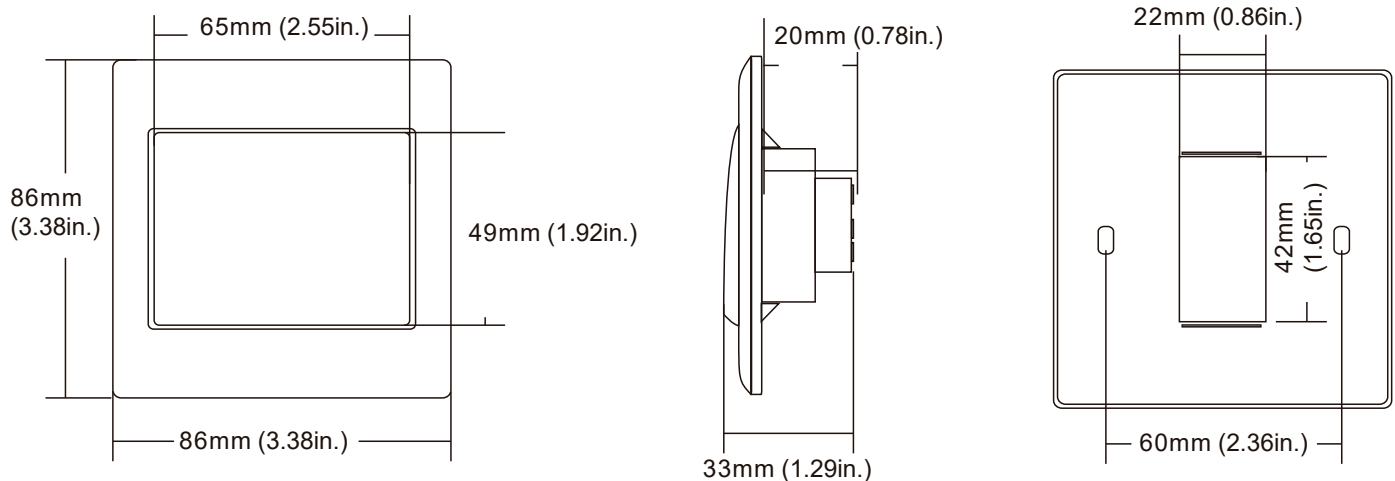

Model No.	VIS-7030
Dimensions	86L*86W*20H mm (3.38*3.38*0.78in.)
Current Rating	3A/125-250VAC
Output Contact	NC/NO/COM Surface
Operating Temp	-20°C~+55°C(-4°F~ 131°F)
Suitable Humidity	0-95% (relative humidity)
Weight	0.045kg
Suitable for Door	Hollow Door
Mechanical Life	100,000 tests

Dimensions



Disclaimer: VISIONIS reserve the right to go ahead with any modifications of models or features or price without forewarning. All the information and specifications stated in this document are current at the time of publication. Attention: We are not responsible for the improper installation of this kit. If you are not handy with electrical equipment you should contact a professional electrician. You will also need to check with your local Fire authority to see if you need anything else to comply with local Fire Codes. We are not responsible for any damage or fees that can occur.



sales@visionistech.com



www.visionistech.com